

DISCHARGE VIEW

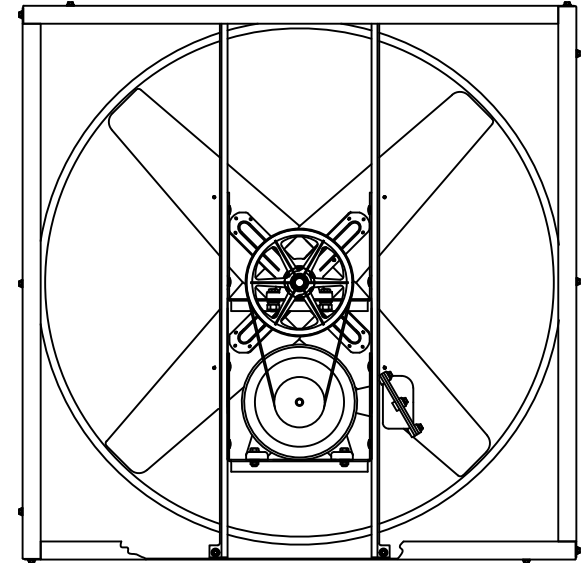
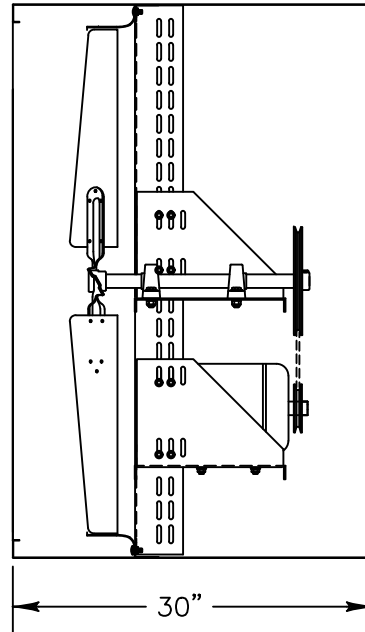

INTAKE VIEW

Exhaust Fan Specifications

Blade Diameter:	36"	Motor Enclosure:	Hazardous Location
Drive:	Belt	Duty Cycle:	Continuous Duty
Horsepower:	1	Guards:	N/A
Voltage:	115/230	Power Cord:	N/A
Phase:	1		
RPM:	555		

*See TriangleFans.com for performance specifications

*Specifications are subject to change without notice



VI3615HL-U

NOT TO SCALE | 28 SEP 2015