

DISCHARGE VIEW

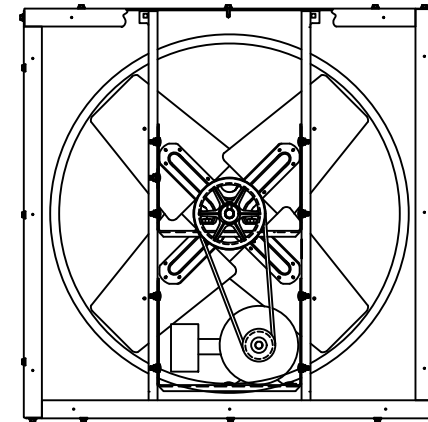
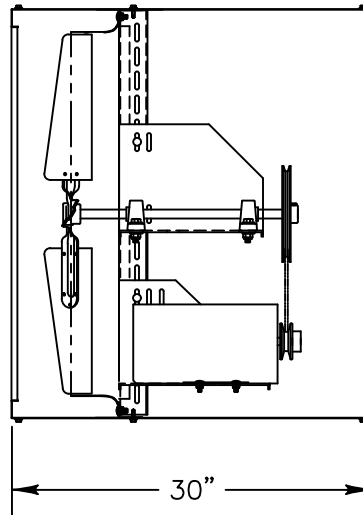

INTAKE VIEW

Exhaust Fan Specifications

Blade Diameter:	30"	Motor Enclosure:	Hazardous Location
Drive:	Belt	Duty Cycle:	Continuous Duty
Horsepower:	3/4	Guards:	N/A
Voltage:	230/460	Power Cord:	N/A
Phase:	3		
RPM:	740		

*See TriangleFans.com for performance specifications
 *Specifications are subject to change without notice



VI3014HL-X

NOT TO SCALE | 29 MAR 2018