

SIDE SECT VIEW

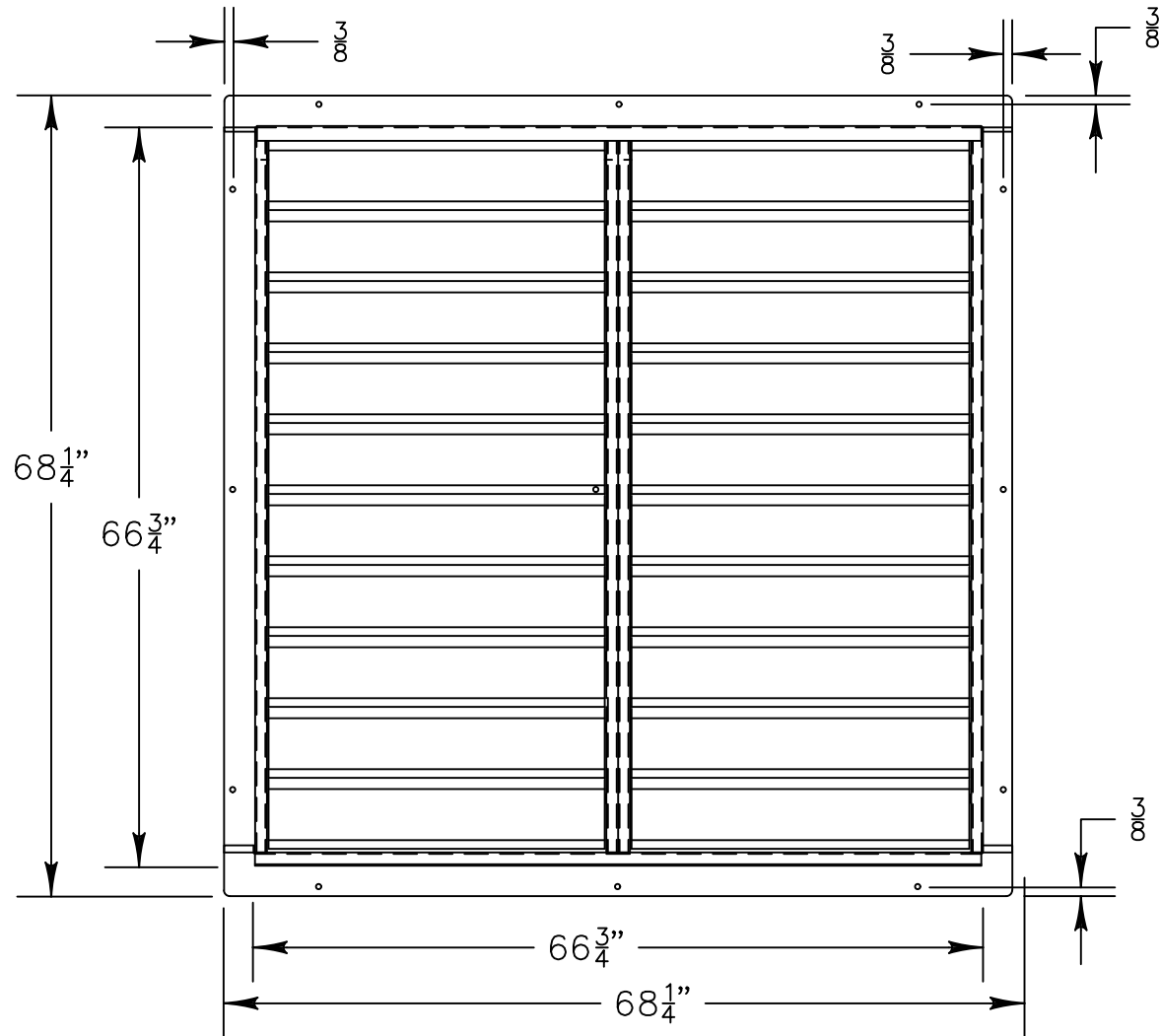

DISCHARGE VIEW

Shutter Specifications

- | | |
|-----------------------------------------------------------------------------------------------------------------------------|-----------------------------------|
| Intended Use: Supply | Blade Material: Extruded Aluminum |
| Frame: Welded Galvanized Steel | Blade Thickness: .050" |
| Finish: Bronze Polyester Powder Coat | Bushings: Bronze Sintered |
| Mounting: Mounts directly to housing of RVI60 Series fans | |
| Note: Must be equipped with an operator and Shutter must be fully opened before fan is energized. Operator sold separately. | |
| *See TriangleFans.com for performance specifications | |
| *Specifications are subject to change without notice | |



RIWSD57

NOT TO SCALE | 13 MAY 1999