

SIDE SECT VIEW

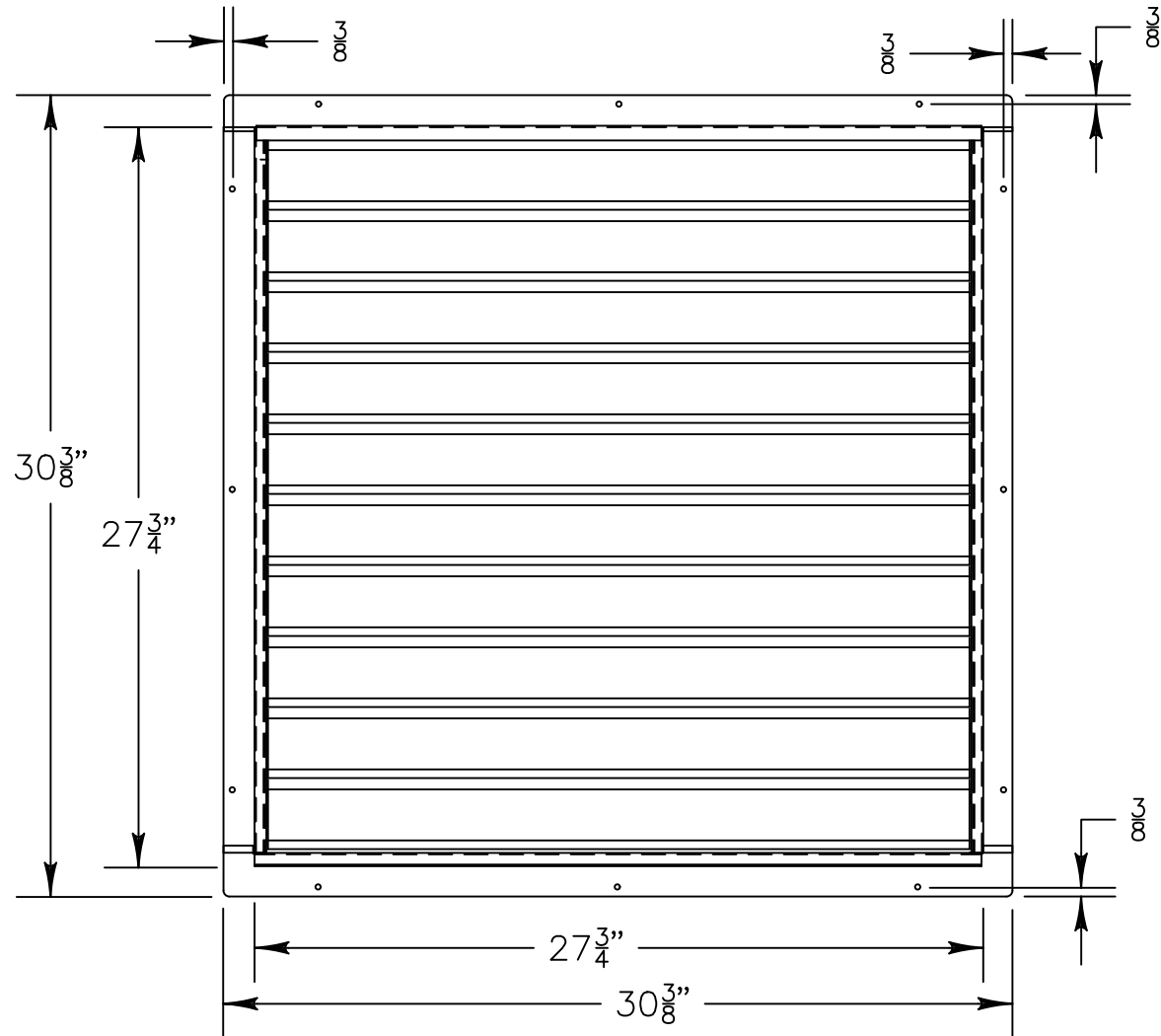

DISCHARGE VIEW

Shutter Specifications

- | | |
|---|-----------------------------------|
| Intended Use: Supply | Blade Material: Extruded Aluminum |
| Frame: Welded Galvanized Steel | Blade Thickness: .050" |
| Finish: Bronze Polyester Powder Coat | Bushings: Bronze Sintered |
| Mounting: Mounts directly to housing of RV124 Series fans | |
| Note: Must be equipped with an operator and Shutter must be fully opened before fan is energized. Operator sold separately. | |
| *See TriangleFans.com for performance specifications | |
| *Specifications are subject to change without notice | |



RIWS21
 NOT TO SCALE | 3 JUN 2015