

DISCHARGE VIEW

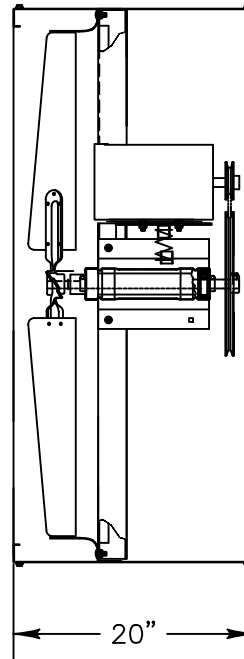

1' X 2" BIRD SCREEN ON
INTAKE AND DISCHARGE SIDES

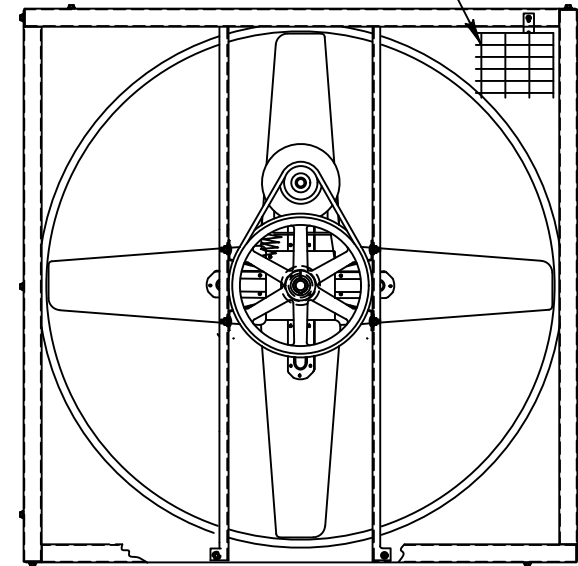

INTAKE VIEW

Fan Specifications

Blade Diameter:	42"	Motor Enclosure:	TEAO
Drive:	Belt	Duty Cycle:	Continuous Duty
Horsepower:	1/2	Guards:	1"X2" Bird Screen
Voltage:	230	Power Cord:	10' with molded plug
Phase:	1		
RPM:	499		

*See TriangleFans.com for performance specifications
*Specifications are subject to change without notice



PFG4213

NOT TO SCALE | 12 DEC 2003